

*Electromagnetic/thermal design and simulation
of electric motors and electromagnetic structures.*

Software: **FLUX**[®] by 

PM Brushless Motors

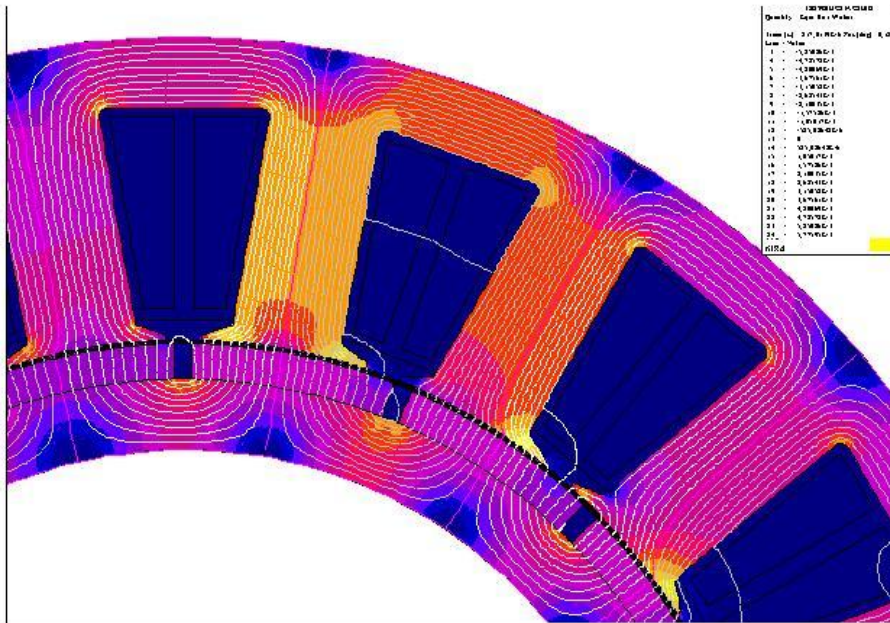

FEM analysis of an inner-rotor, surface-mounted PM brushless motor.

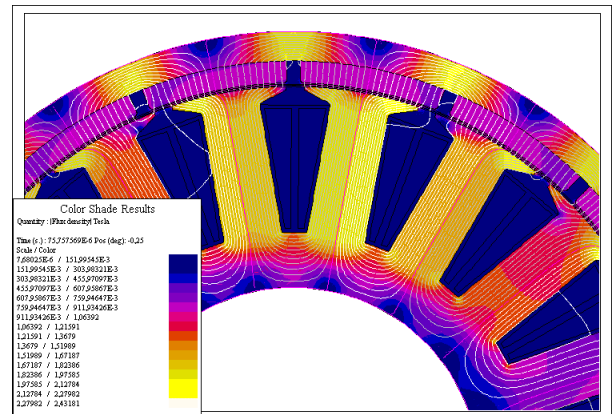
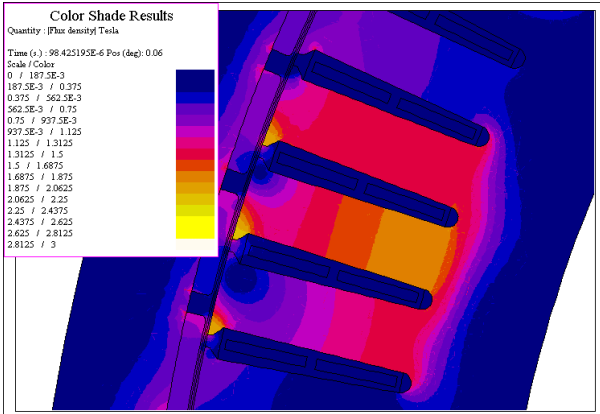

FEM analysis of outer-rotor, surface-mounted PM brushless motors.

Induction Motors

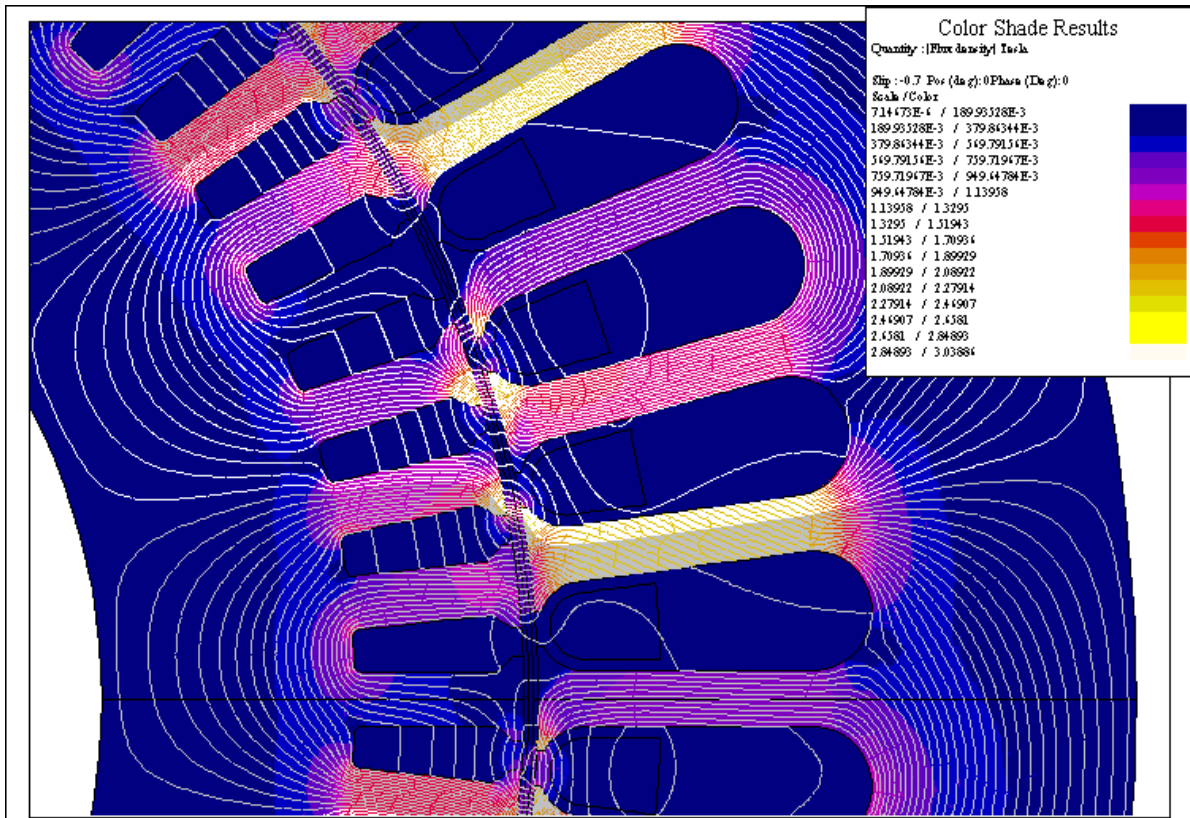

FEM analysis of a three-phase squirrel cage induction motor.

Electromagnets

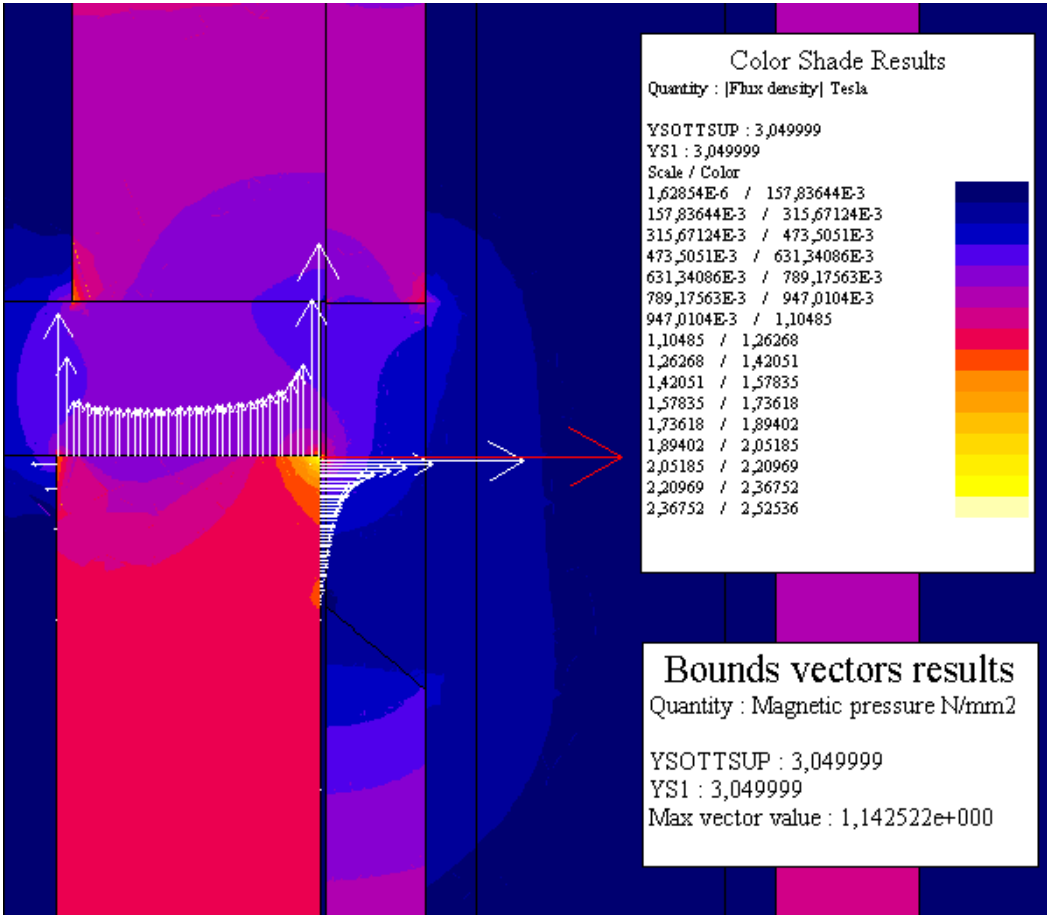

FEM analysis of an electromagnet

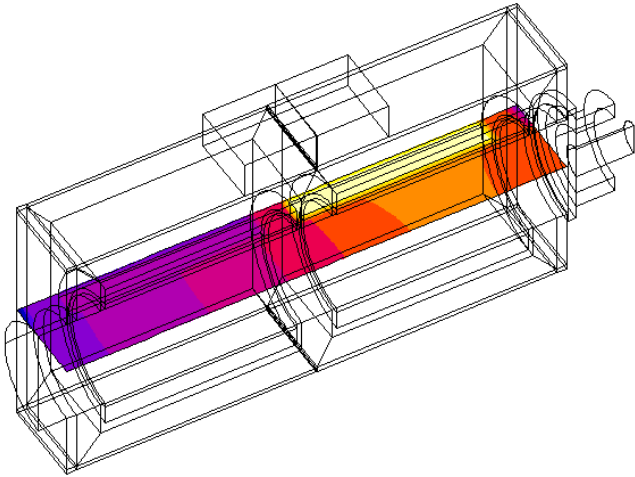
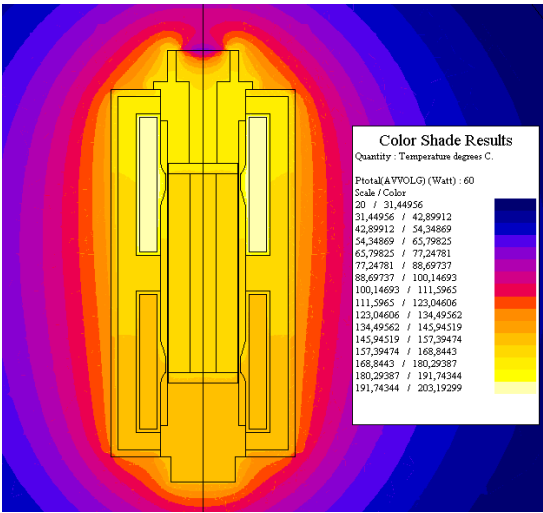

3D Thermal analysis of an electromagnet.